

LISTY PRO ZÁCHRANÁŘE

Škoda

Název modelu

Cyklus modelu

F

- Felicia
- Felicia Combi
- Fabia I
- Fabia Sedan I
- Fabia Combi I
- Fabia II
- Fabia Combi II

1994 - 2001
1995 - 2001
1999 - 2007
2001 - 2008
2000 - 2007
od 2006
od 2006

O

- Octavia I
- Octavia Combi I
- Octavia II
- Octavia Combi II
- Octavia II LPG
- Octavia Combi II LPG

od 1996
od 2000
od 2004
od 2004
od 2009
od 2009

P

- Pick up

1995 - 2001

R

- Roomster

od 2006

S

- Superb I
- Superb II
- Superb Combi II

2001 - 2008
od 2008
od 2009

Y

- Yeti

od 2009



Pro rychlé vyhledávání
na pravém okraji stránky



Upozornění:

Tato dokumentace byla zhotovena výhradně pro záchranné služby, které mají speciální vzdělání v oblasti technické pomoci po dopravních nehodách a znají tedy činnosti v této dokumentaci popisované.

Specifikace a mimořádné vybavy vozu Škoda a nabídka vozu společnosti Škoda Auto a.s. trvale podléhají případným změnám. Proto si Škoda Auto a.s. vyhrazuje právo kdykoliv provést obsahové úpravy resp. změny této dokumentace.

Nezapomeňte prosím, že informace obsažené v této dokumentaci nejsou určeny pro koncového zákazníka ani pro servisy a prodejce.

Koncoví zákazníci naleznou podrobné informace o funkcích jejich vozu a důležité bezpečnostní pokyny, týkající se bezpečnosti vozu a cestujících v příslušných palubních brožurách každého vozu Škoda. Servisy a prodejci mohou získat potřebné informace týkající se oprav na místech, která znají.

(Stav: říjen 2009)

Upozornění:

V přehledech modelů je uvedena vždy maximálně možná výbava vozu.

Číslo výrobku S00 5186 53 15

Obecné informace o zachraňování a vyprošťování naleznete v příručce pro záchranáře „Zachraňování a vyprošťování z havarovaných vozidel“ ve stejnojmenné brožuře s číslem výrobku S00 5186 26 15.







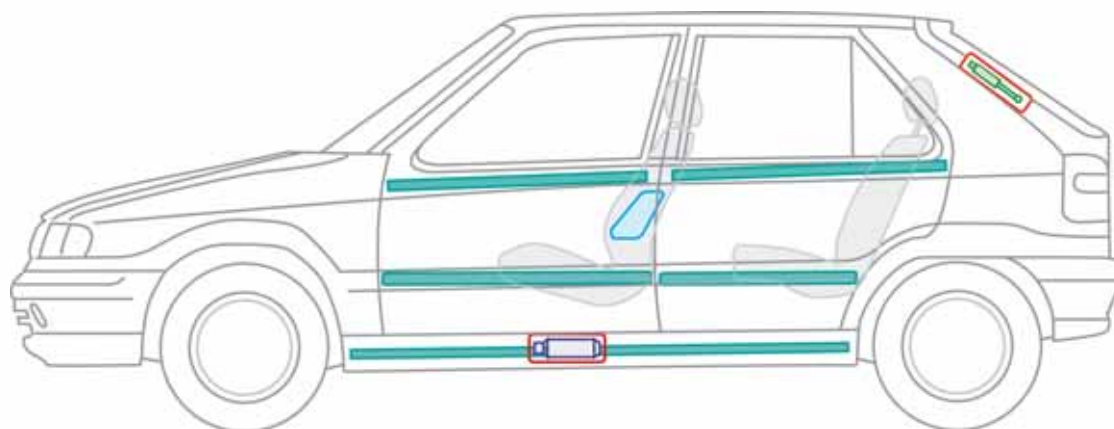
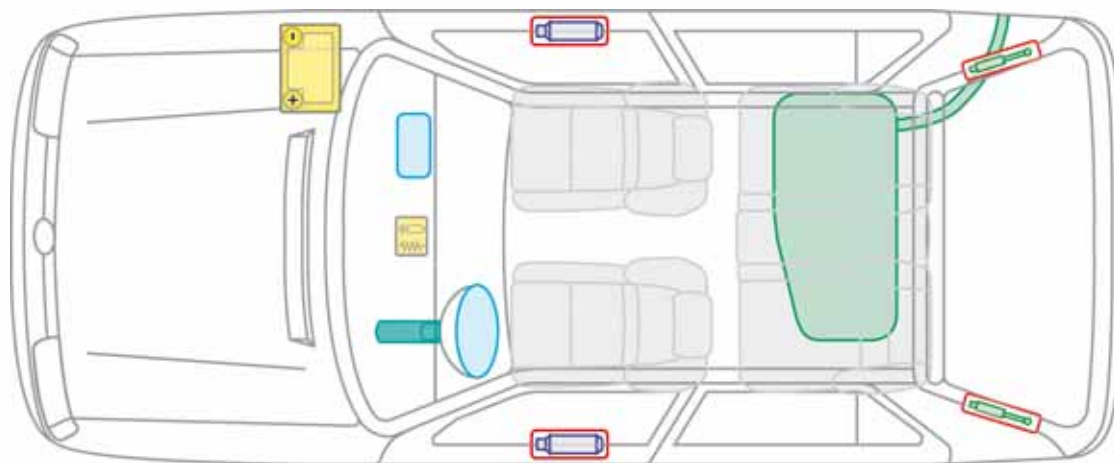

Škoda SIMPLY CLEVER

Felicia

1994 - 2001



Legenda





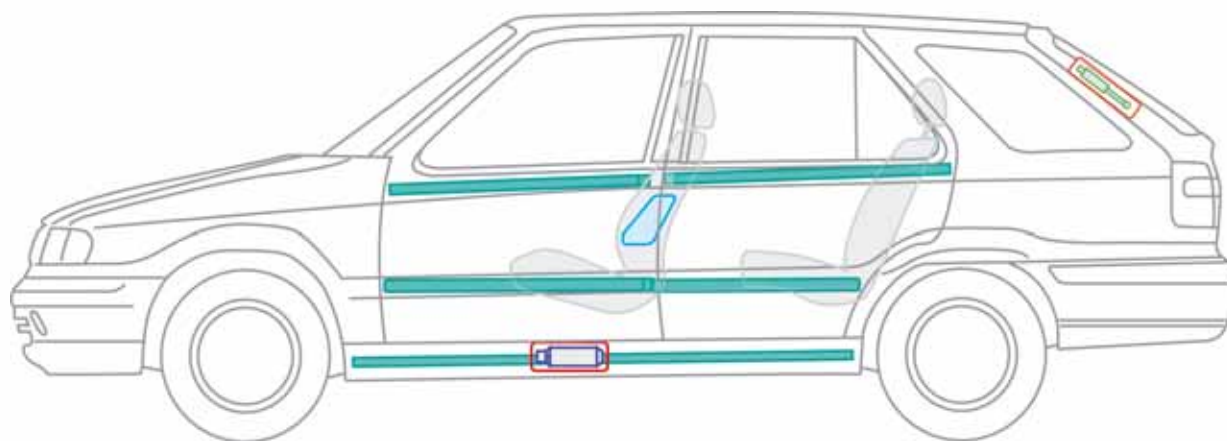
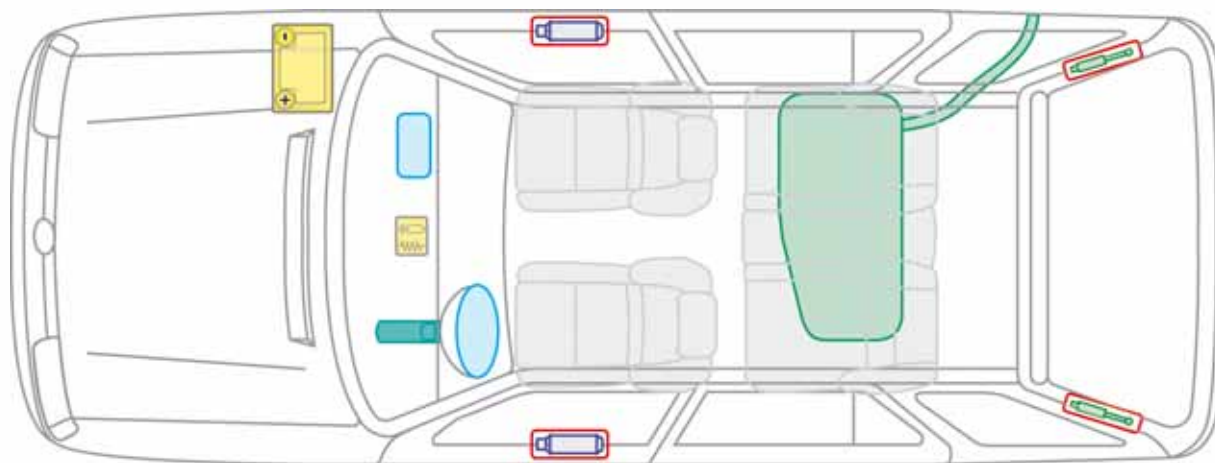

	Airbag		Vyztužení karoserie		Řídicí jednotka airbagu
	Plynový generátor		Akumulátor		Plynová vzpěra
	Palivová nádrž				

Felicia Combi

1995 - 2001



Legenda

	Airbag		Vyztužení karoserie		Řídicí jednotka airbagu
	Plynový generátor		Akumulátor		Plynová vzpěra
	Palivová nádrž				

F

Felicia Combi





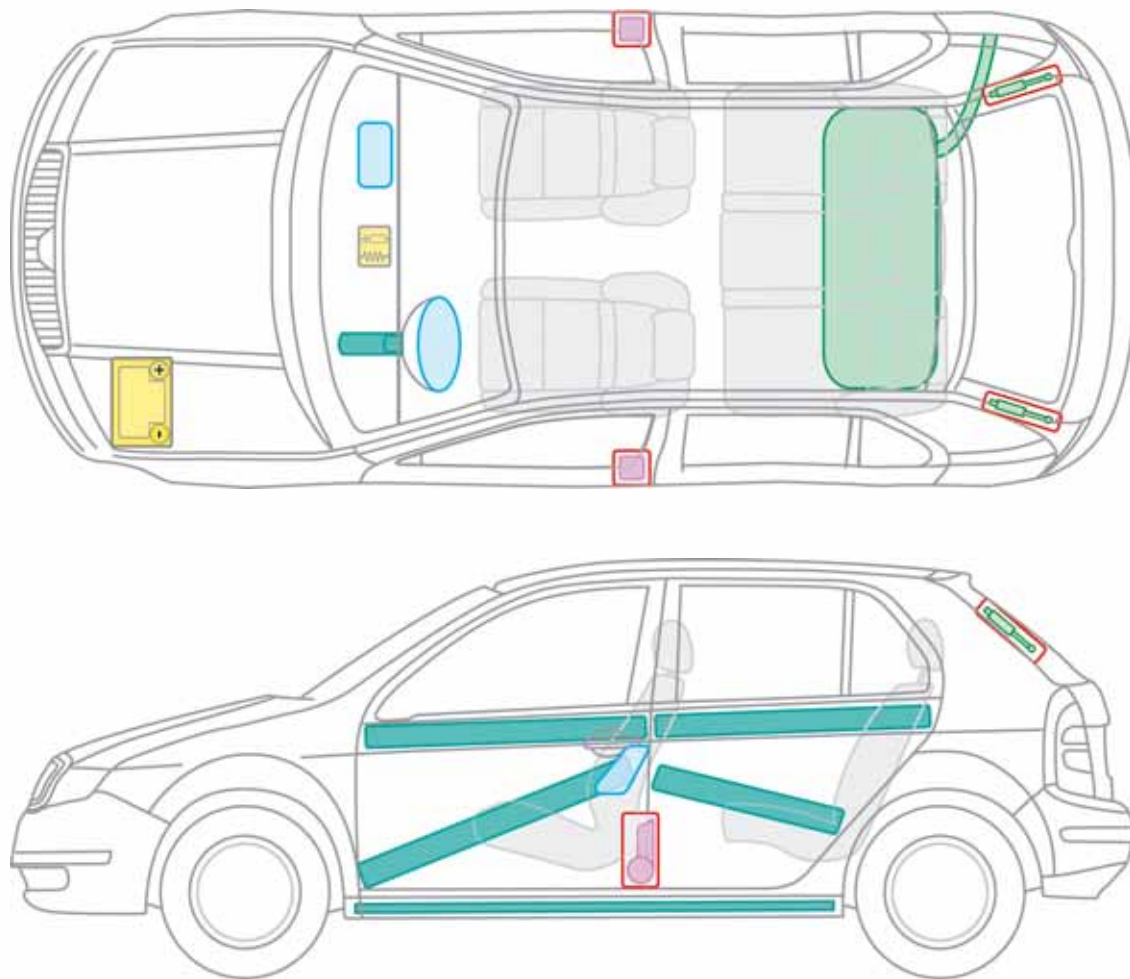

Fabia I

1999 - 2007



Legenda

	Airbag		Vyztužení karoserie		Řídicí jednotka airbagu
	Akumulátor		Předepínač bezpečnostního pásu		Plynová vzpěra
	Palivová nádrž				

Fabia Sedan I

2001 - 2008

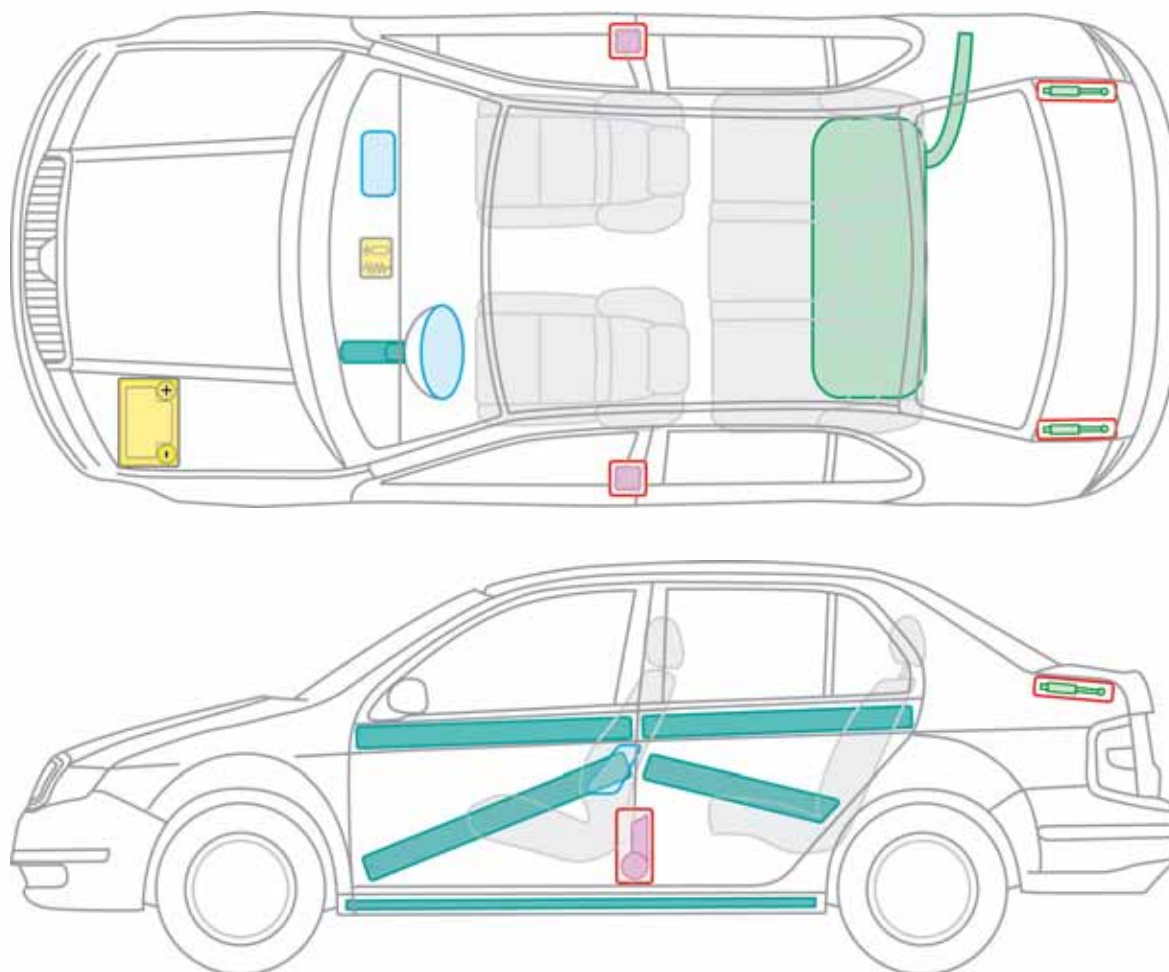

Legenda



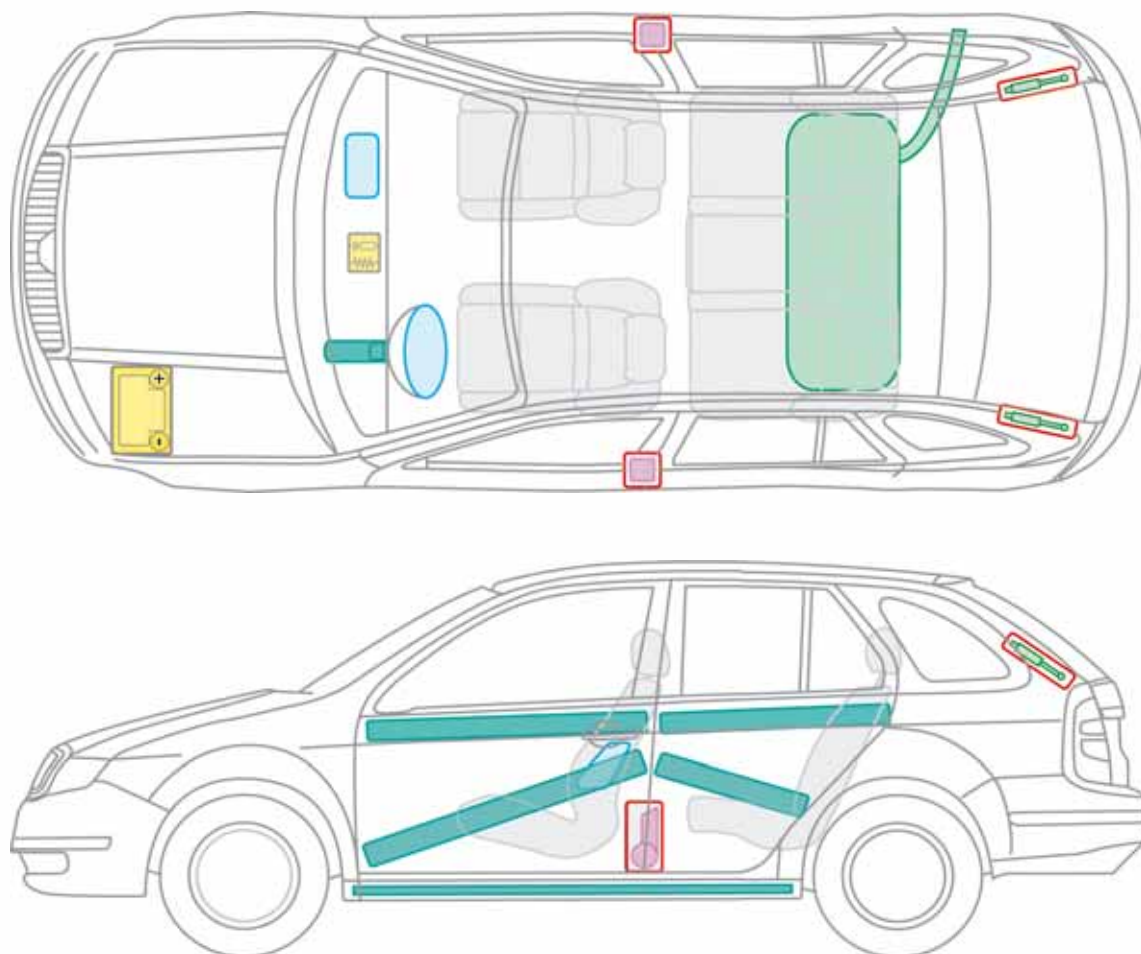

	Airbag		Vyztužení karoserie		Řídicí jednotka airbagu
	Akumulátor		Předepínač bezpečnostního pásu		Plynová vzpěra
	Palivová nádrž				

Fabia Combi I

2000 - 2007

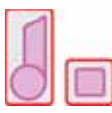

Legenda

	Airbag		Vyztužení karoserie		Řídicí jednotka airbagu
	Akumulátor		Předepínač bezpečnostního pásu		Plynová vzpěra
	Palivová nádrž				

F





Fabia Combi I

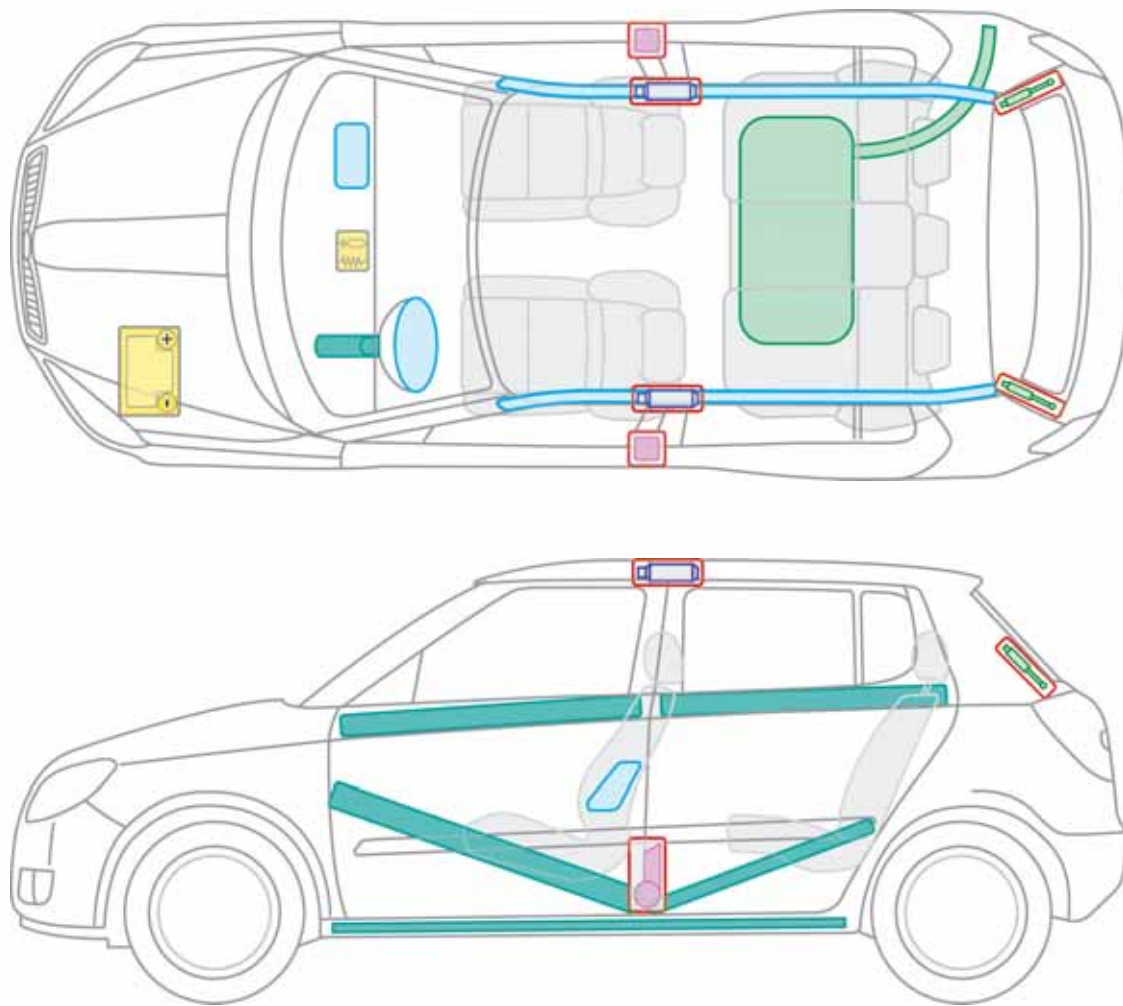

Fabia II od 2006



Legenda

	Airbag		Vyztužení karoserie		Řídicí jednotka airbagu
	Plynový generátor		Akumulátor		Předepínač bezpečnostního pásu
	Plynová vzpěra		Palivová nádrž		

Fabia Combi II od 2006

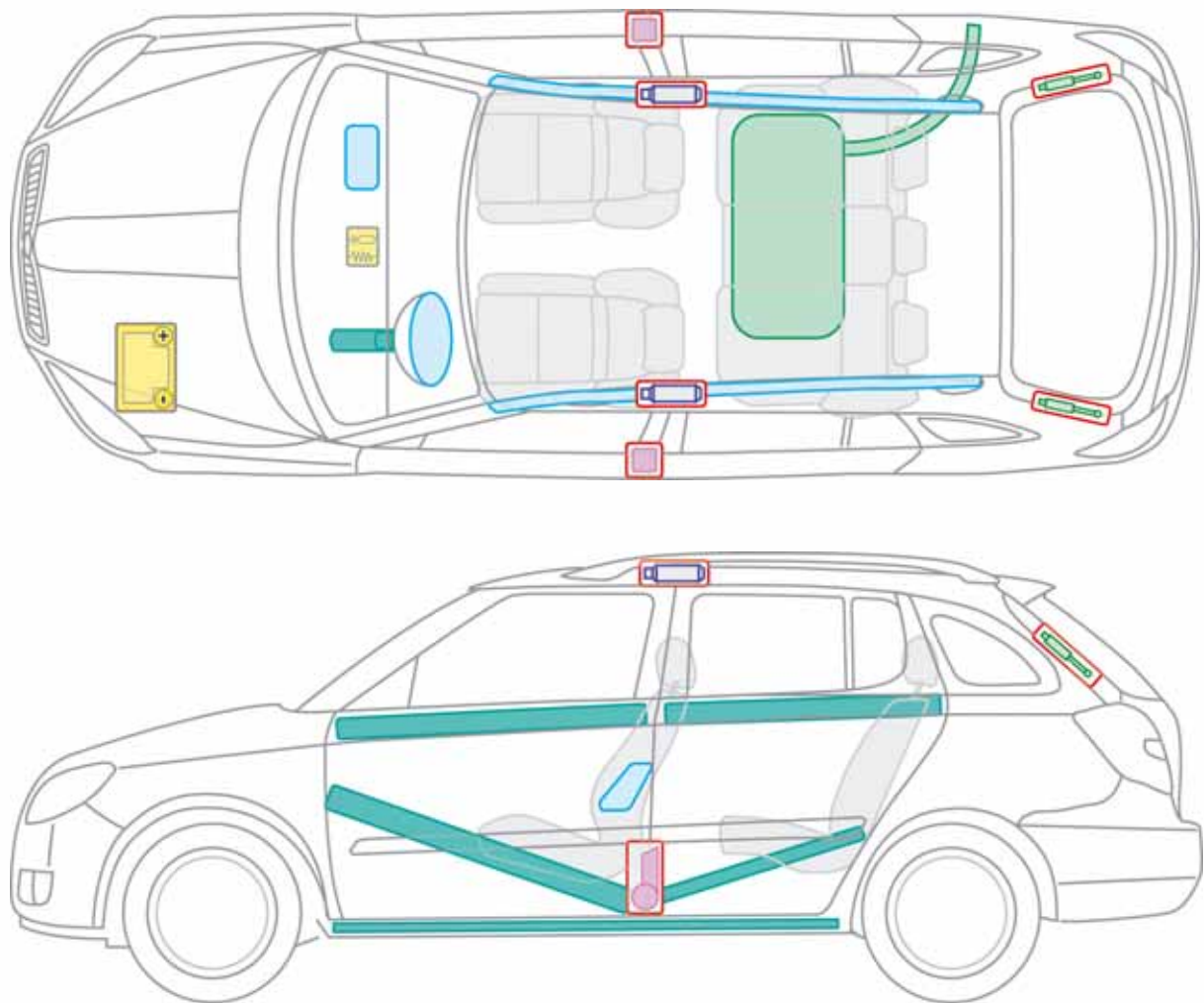

Legenda

	Airbag		Vyztužení karoserie		Řídicí jednotka airbagu
	Plynový generátor		Akumulátor		Předepínač bezpečnostního pásu
	Plynová vzpěra		Palivová nádrž		

Octavia I od 1996

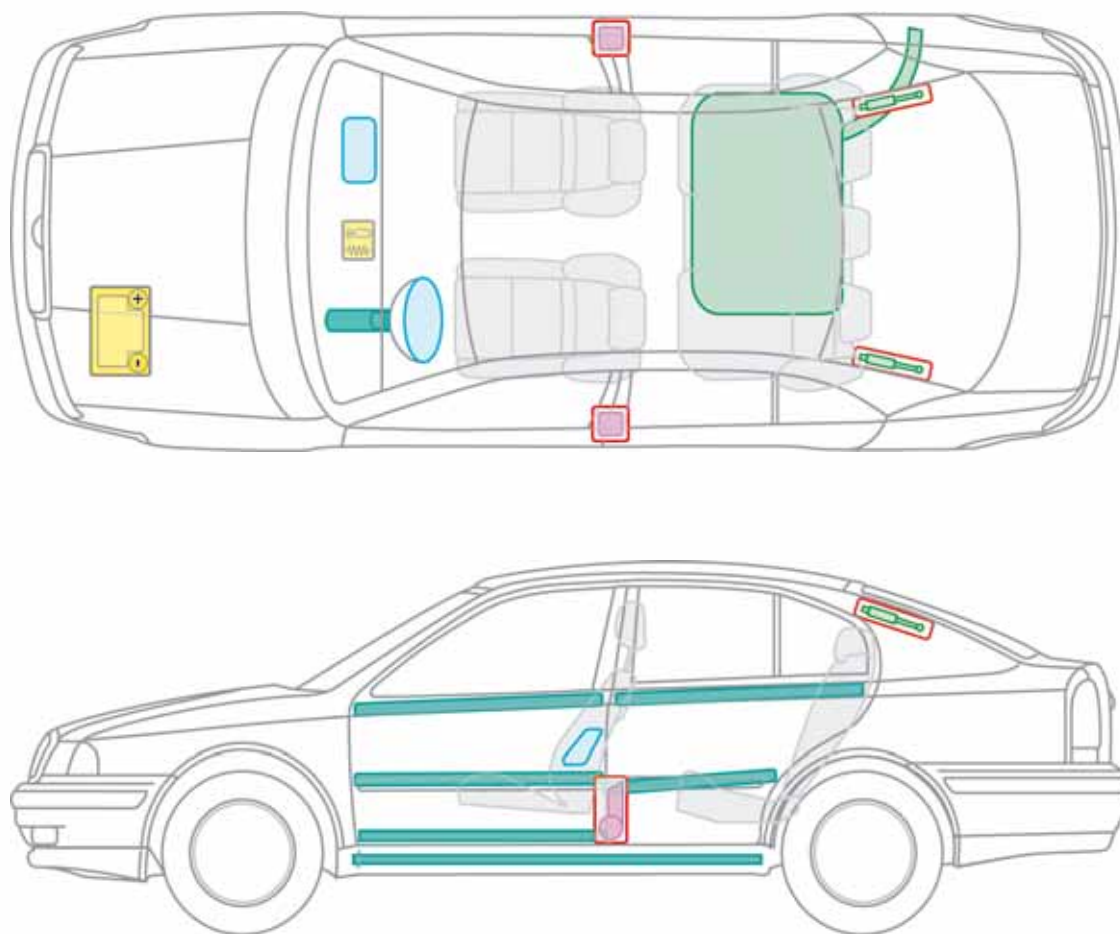



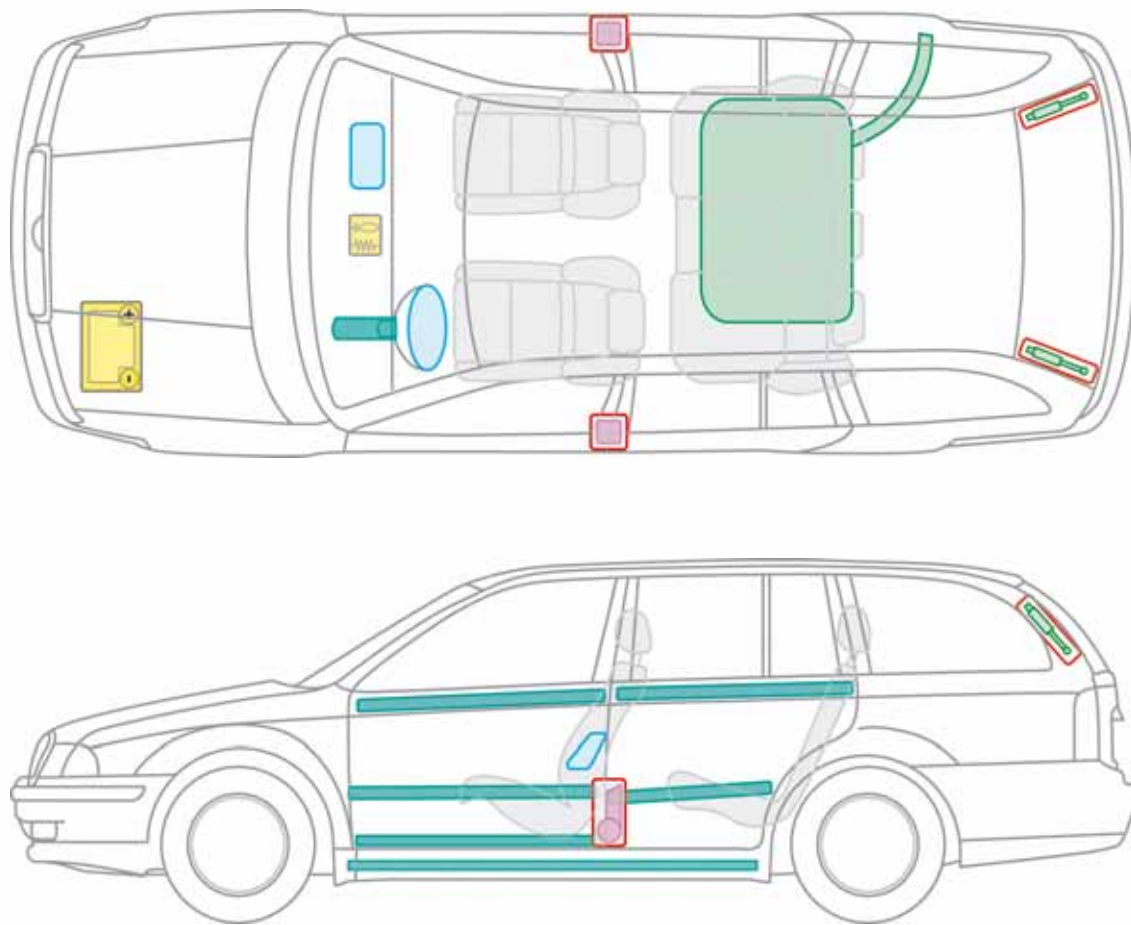

Legenda

	Airbag		Vyztužení karoserie		Řídicí jednotka airbagu
	Akumulátor		Předeplínač bezpečnostního pásu		Plynová vzpěra
	Palivová nádrž				

Octavia Combi I od 2000



Legenda

	Airbag		Vyztužení karoserie		Řídicí jednotka airbagu
	Akumulátor		Předepínač bezpečnostního pásu		Plynová vzpěra
	Palivová nádrž				

O

Octavia Combi I



Octavia II od 2004

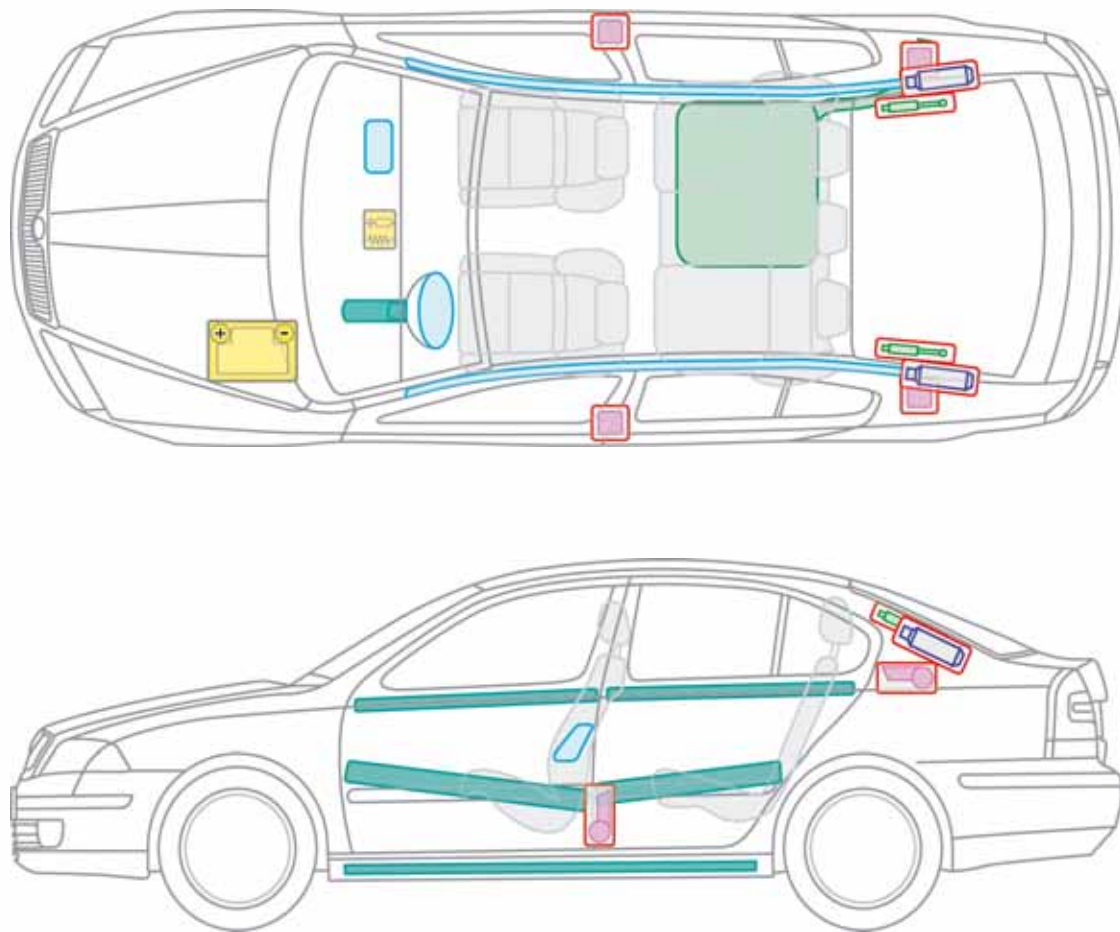





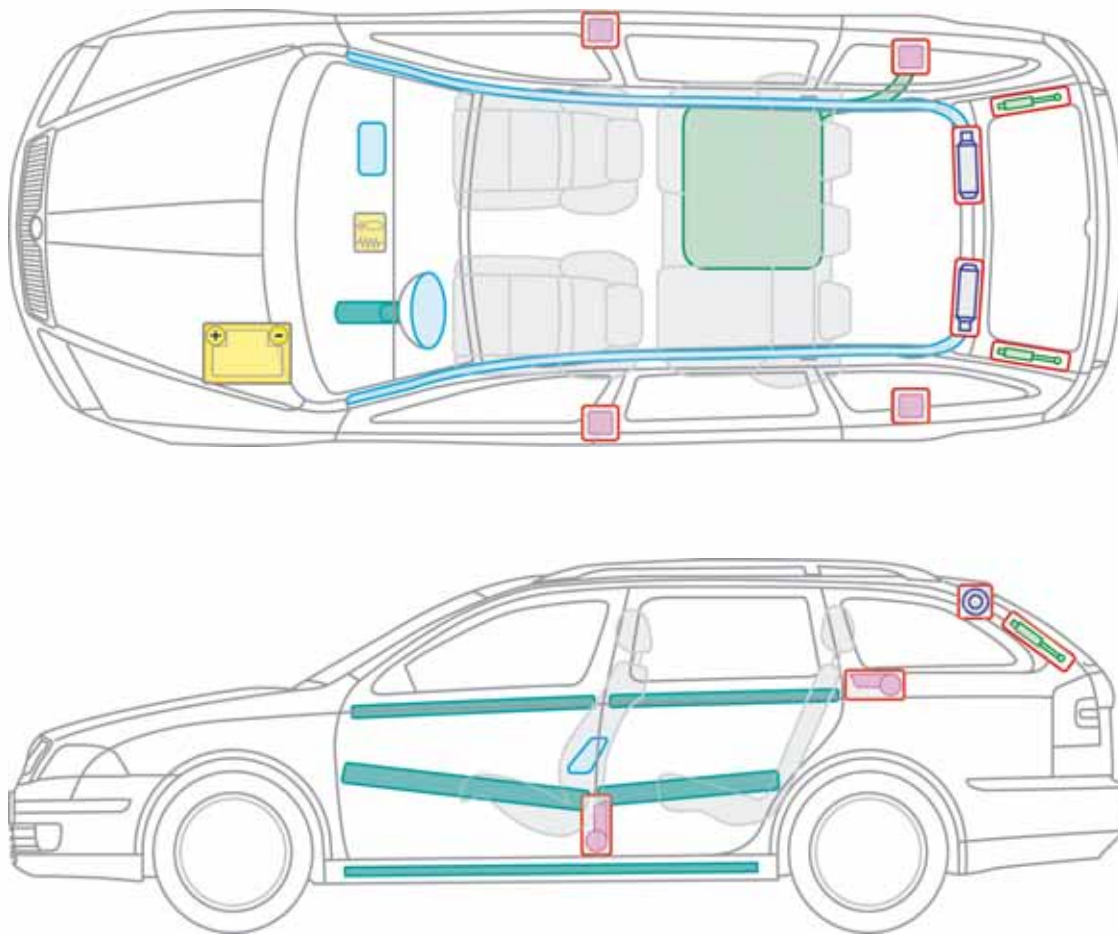

Legenda

	Airbag		Vyztužení karoserie		Akumulátor		Řídicí jednotka airbagu
	Plynový generátor		Palivová nádrž		Předepínač bezpečnostního pásu		
	Plynová vzpěra						

Octavia Combi II od 2004



Legenda

	Airbag		Vyztužení karoserie		Řídicí jednotka airbagu
	Plynový generátor		Akumulátor		Předepínač bezpečnostního pásu
	Plynová vzpěra		Palivová nádrž		

O

Octavia Combi II



Octavia II LPG

od 2009

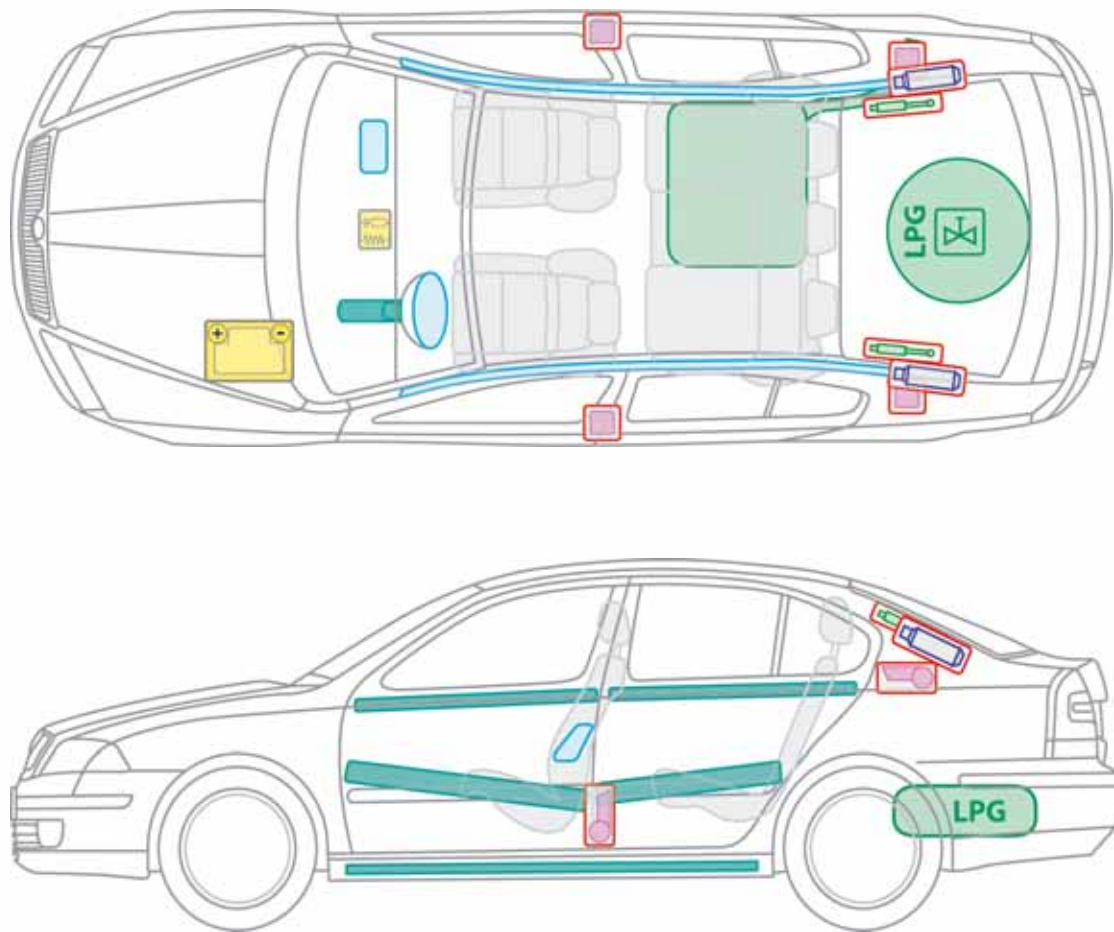

Legenda

	Airbag		Vyztužení karoserie		Řídicí jednotka airbagu
	Plynový generátor		Akumulátor		Předepínač bezpečnostního pásu
	Plynová vzpěra		Palivová nádrž		Multifunkční ventil

O

Octavia II LPG



Octavia Combi II LPG od 2009

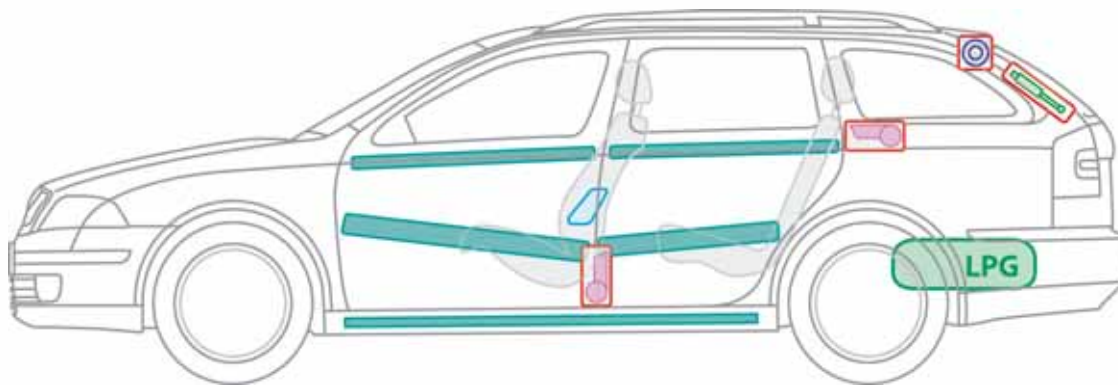
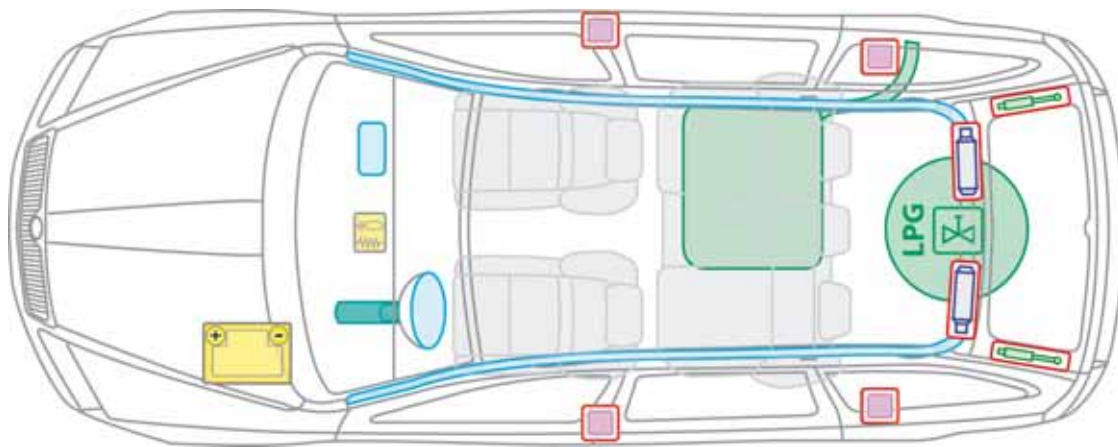

Legenda

	Airbag		Vyztužení karoserie		Řídicí jednotka airbagu
	Plynový generátor		Akumulátor		Předepínač bezpečnostního pásu
	Plynová vzpěra		Palivová nádrž		Multifunkční ventil

Pick up 1995 - 2001

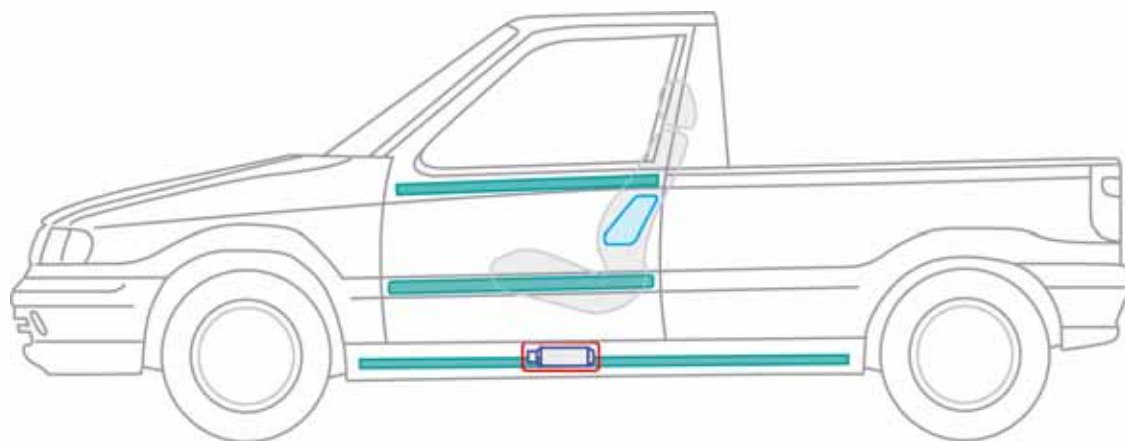
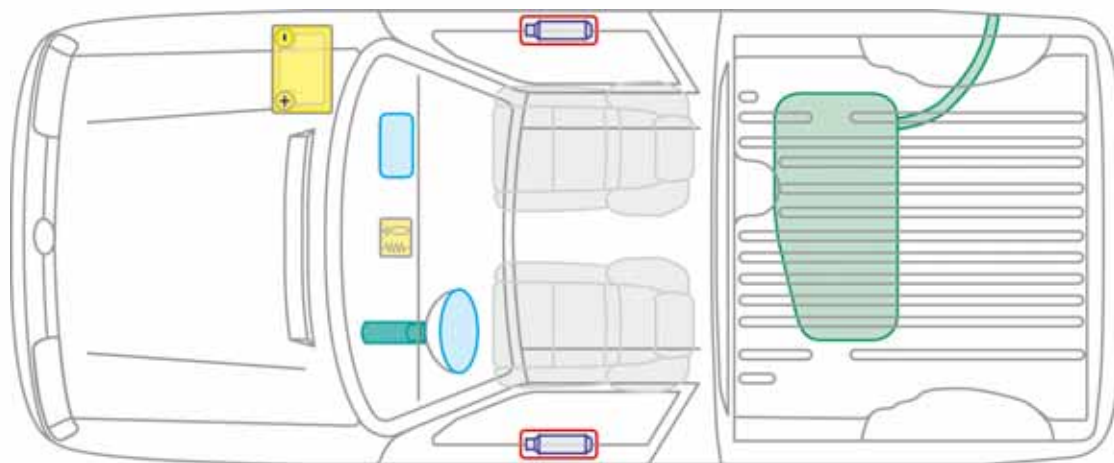

Legenda

	Airbag		Vyztužení karoserie		Řídicí jednotka airbagu
	Plynový generátor		Akumulátor		Plynová vzpěra
	Palivová nádrž				

P





Pick up

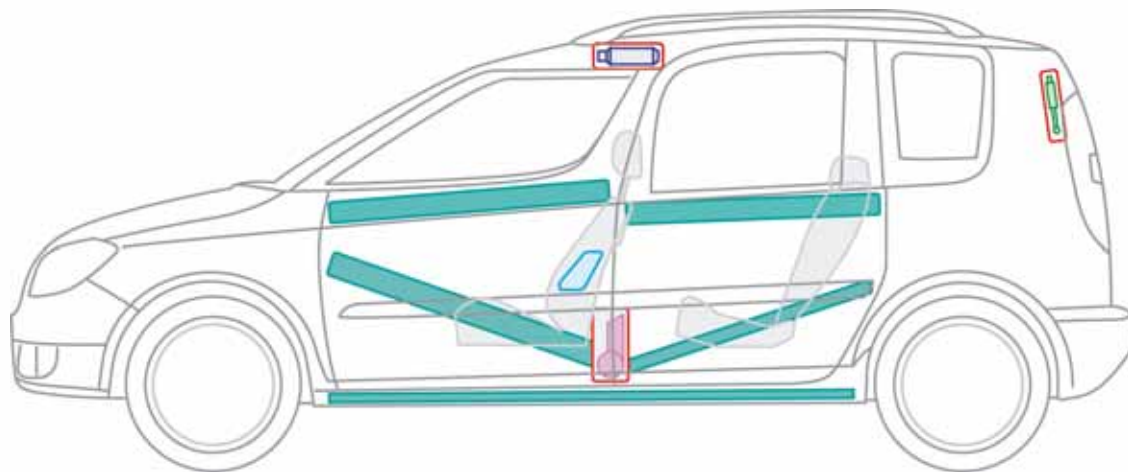
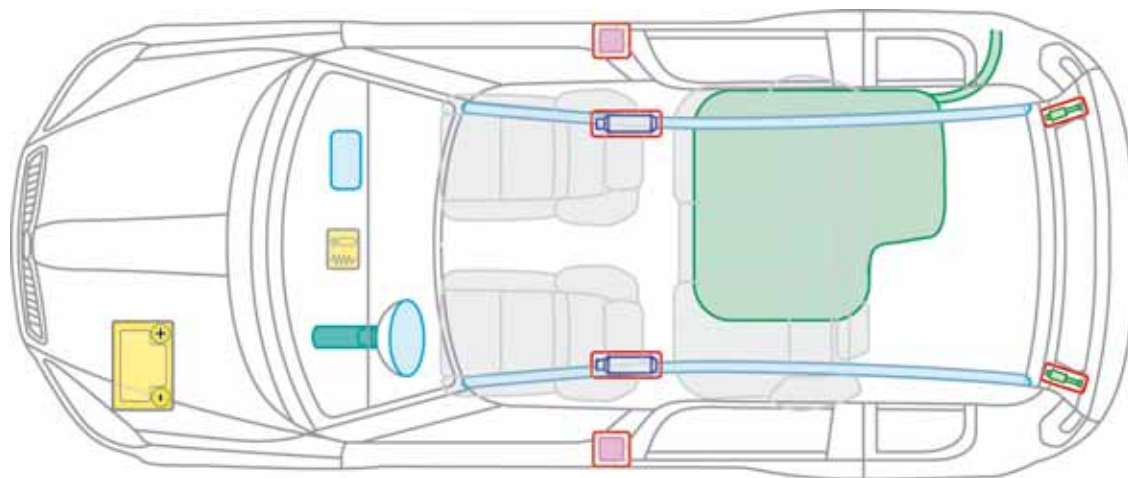

Roomster od 2006



Legenda

	Airbag		Vyztužení karoserie		Řídicí jednotka airbagu
	Plynový generátor		Akumulátor		Předepínač bezpečnostního pásu
	Plynová vzpěra		Palivová nádrž		

R





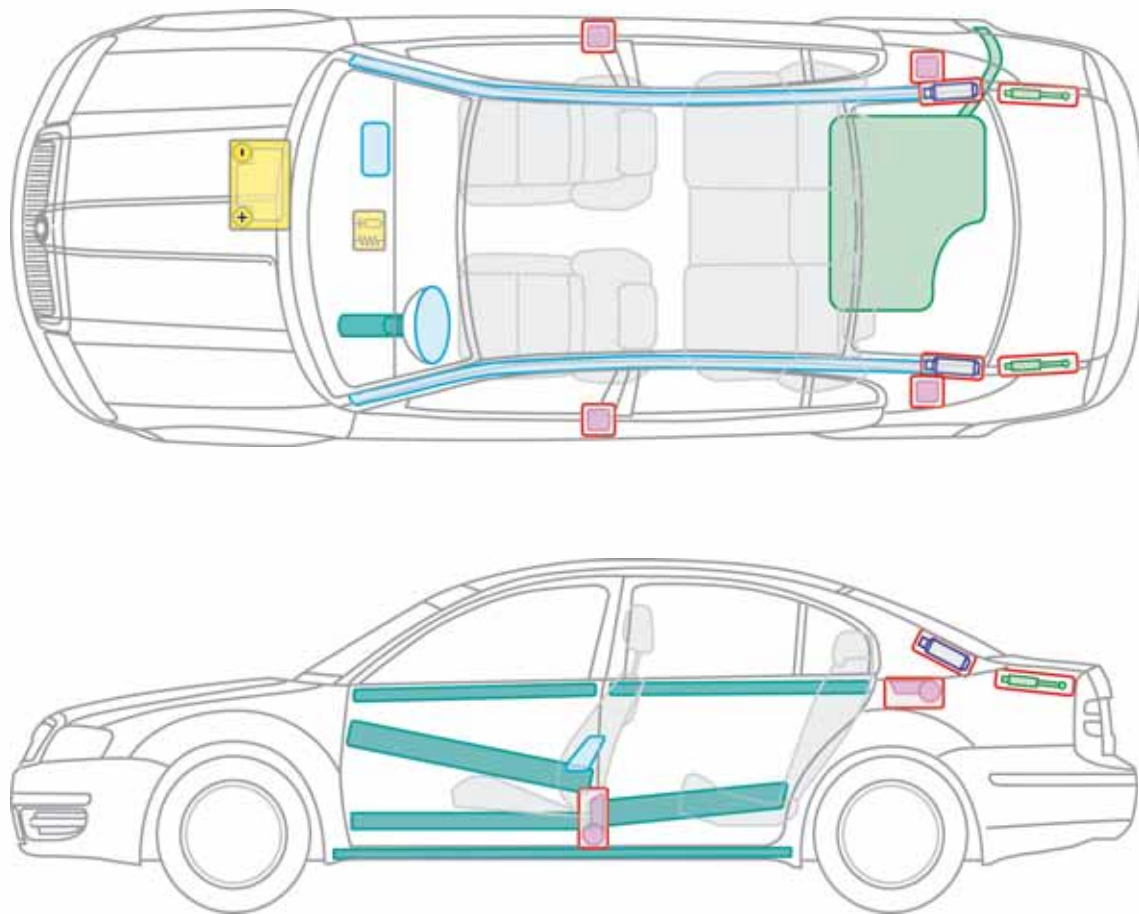

Roomster



Superb I 2001 - 2008



Legenda

	Airbag		Vyztužení karoserie		Řídicí jednotka airbagu
	Plynový generátor		Akumulátor		Předepínač bezpečnostního pásu
	Plynová vzpěra		Palivová nádrž		

S

Superb I



Superb II od 2008

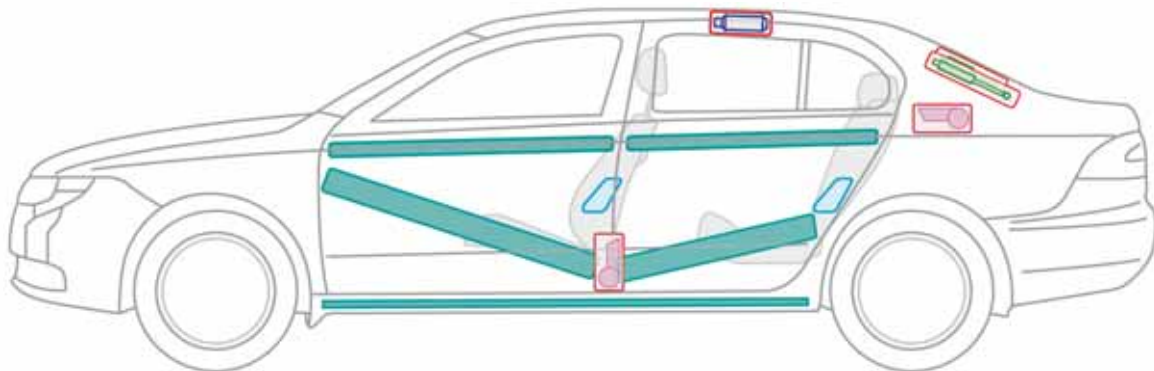
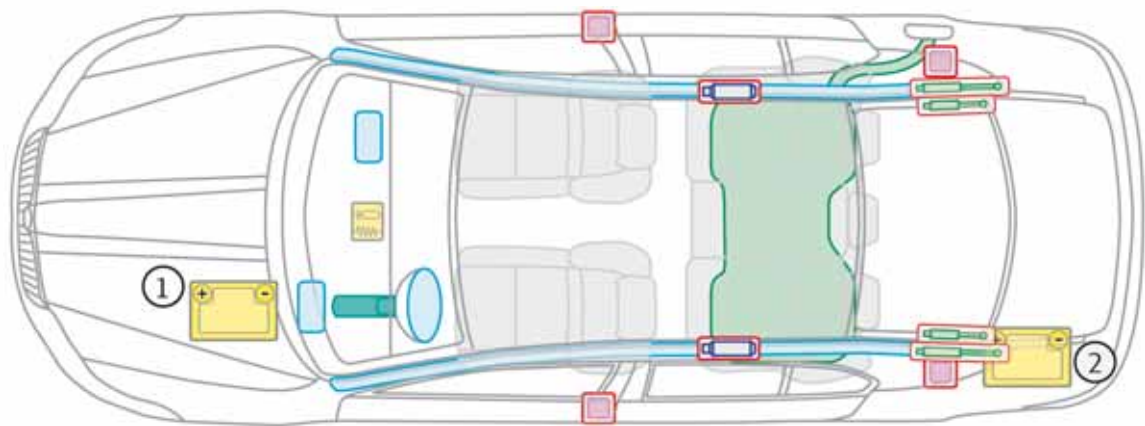

- ① všechna vozidla, kromě motorizace 3,6 l/191 kW
 ② všechna vozidla s motorizací 3,6 l/191 kW

Legenda

	Airbag		Vyztužení karoserie		Řídicí jednotka airbagu
	Plynový generátor		Akumulátor		Předepínač bezpečnostního pásu
	Plynová vzpěra		Palivová nádrž		

S

Superb II



Superb Combi II od 2009

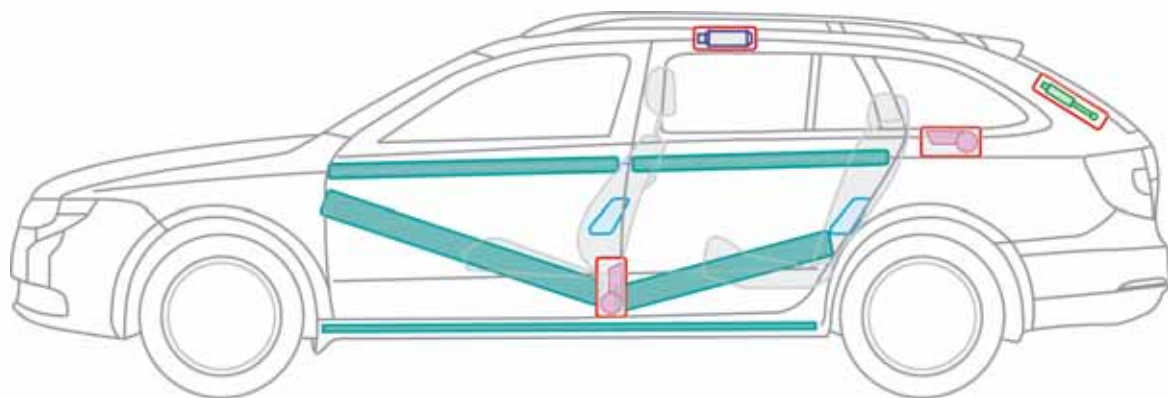
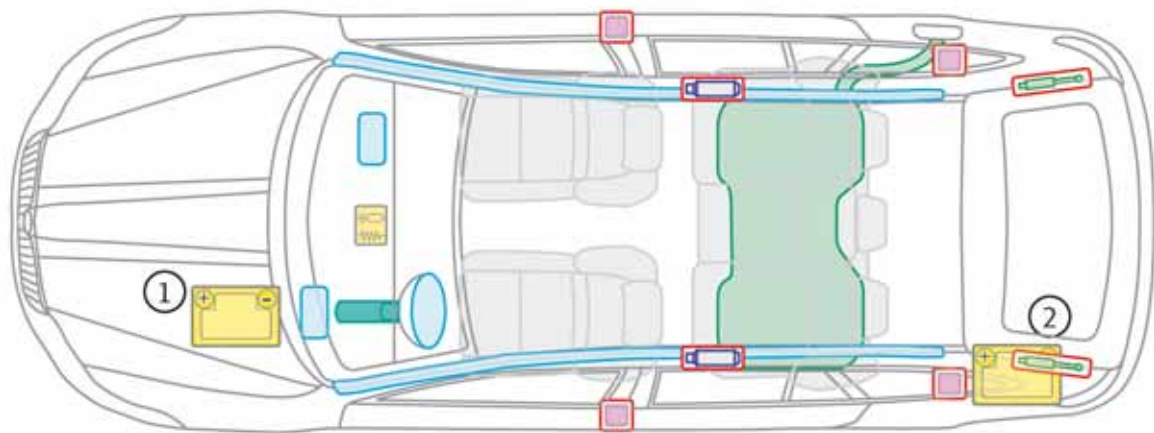

- ① všechna vozidla, kromě motorizace 3,6 l/191 kW
 ② všechna vozidla s motorizací 3,6 l/191 kW

Legenda

	Airbag		Vyztužení karoserie		Akumulátor		Řídicí jednotka airbagu
	Plynový generátor		Palivová nádrž		Předepínač bezpečnostního pásu		Plynová vzpěra

S

Superb Combi II



Yeti
od 2009

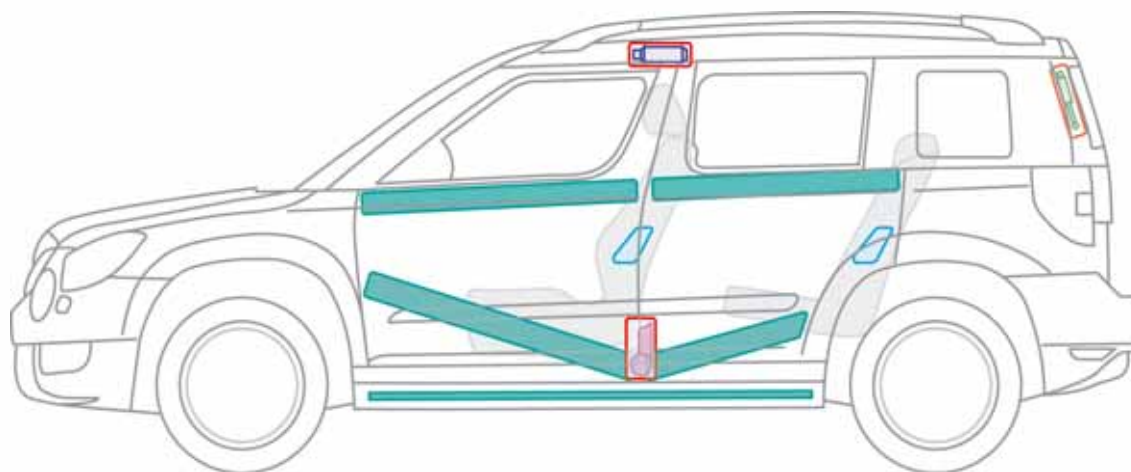
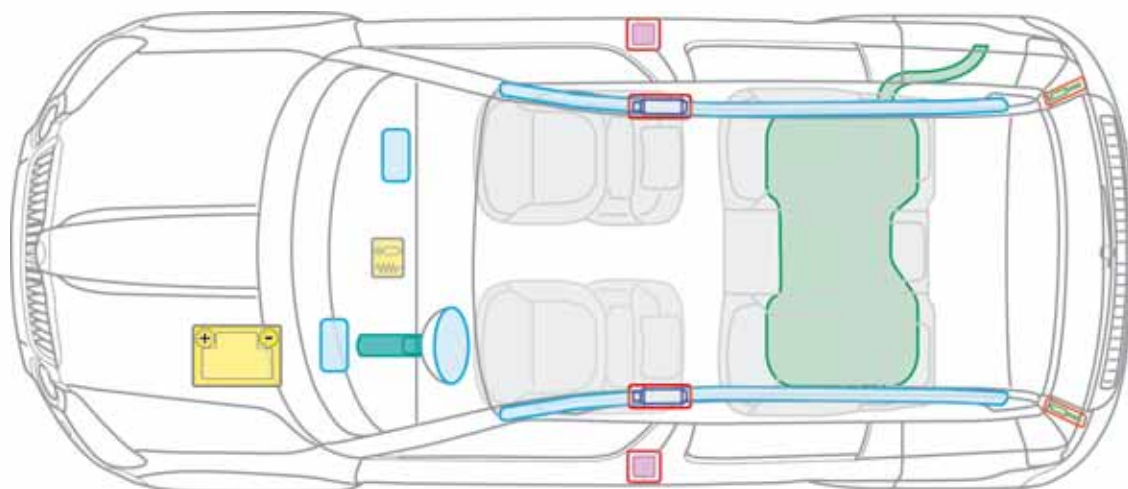

Legenda

	Airbag		Vyztužení karoserie		Řídicí jednotka airbagu
	Plynový generátor		Akumulátor		Předepínač bezpečnostního pásu
	Plynová vzpěra		Palivová nádrž		

Y

Yeti

